

Array Pendant

with opal glass shades

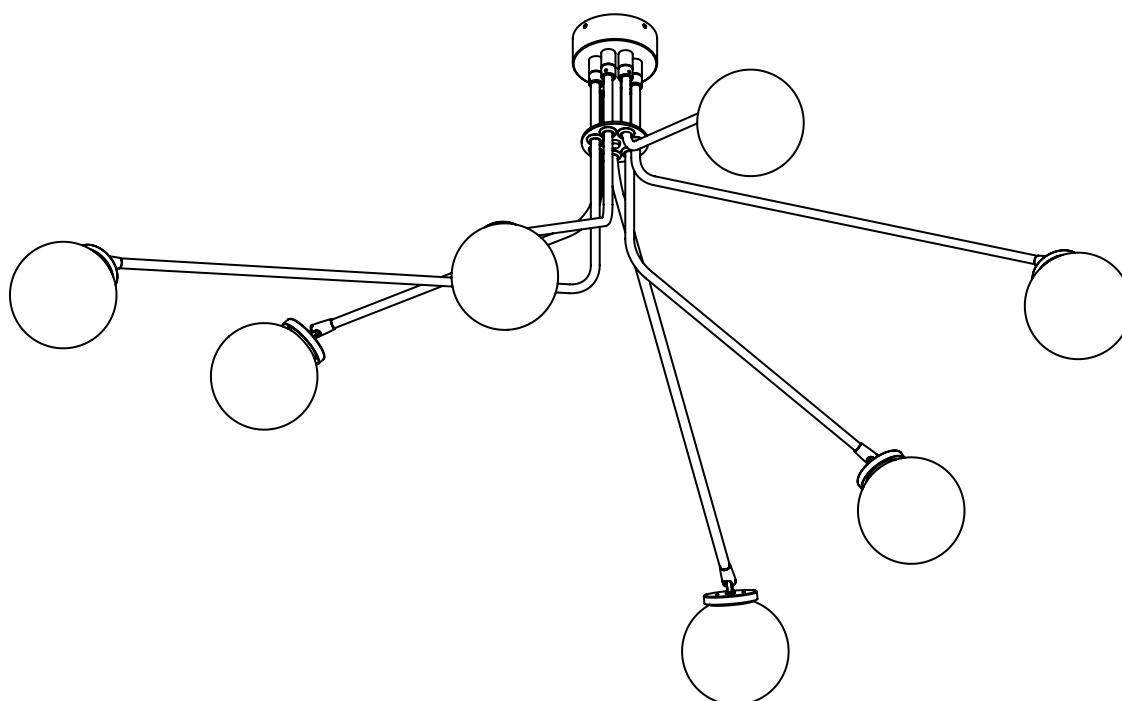

! Please handle with care and wear gloves at all times during assembly and installation to avoid damaging or marking the components.

TECHNICAL

bulb holder	7 x G9 mains halogen
wattage	7 x 25 watts
weight	15 kg (33 lbs)
cleaning	dust using a dry lint-free cloth weekly or as required
replacement/ repairs	please contact CTO Lighting
warranty	CTO Lighting warranty, 1 year from date of delivery
certification	CE compliant

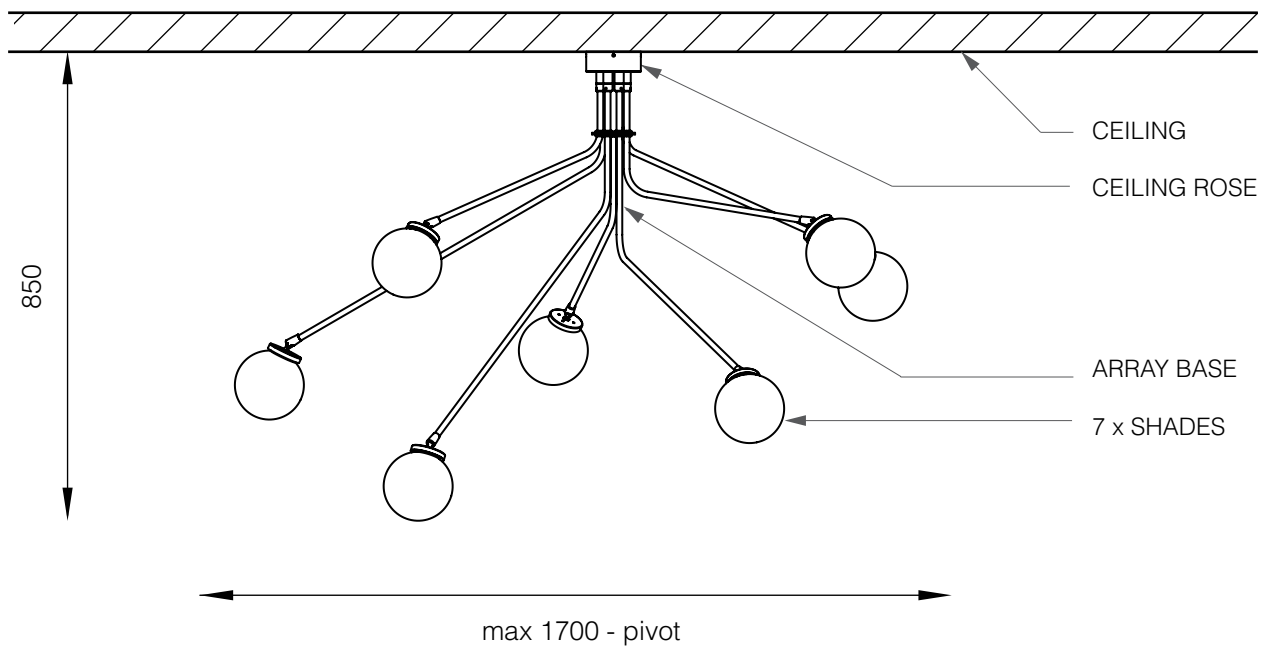

BEFORE INSTALLATION

- Installation **must** be carried out by a qualified electrician.
- A minimum of **two people** required to install this pendant.
- Check that the ceiling and components are suitable and strong enough to support the weight of the pendant.

INSTALLATION

1. Remove the zinc ceiling plate from the ceiling rose and fix to the ceiling. Ensure that suitable screws are being used for the surface that you are mounting to.

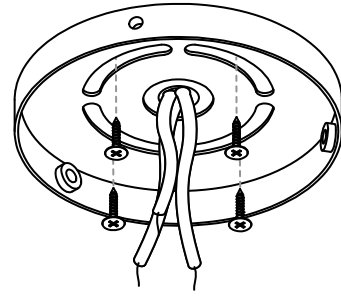

2. Raise the pendant towards the ceiling and make the electrical connection. Further raise the pendant, closing the ceiling rose over the mounted plate and secure with the screws provided.

note: Ensure that the weight of the pendant is fully supported during the electrical installation.

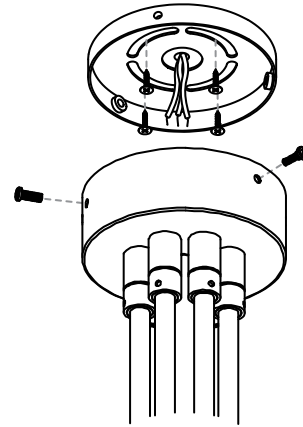

3. Fit the bulbs and shades to the pendant base. Pinch the sprung clips inwards and hold, slowly feeding the opal glass shade over the sprung clips. **Do not** release the opal glass shades too quickly.

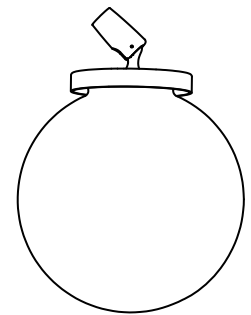
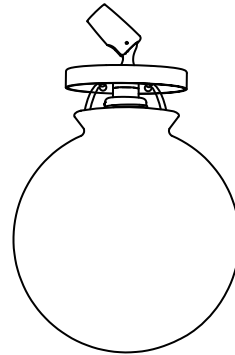
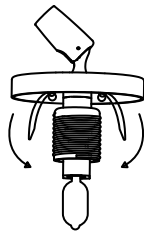

4. Adjust the angles of all of the arms to create the configuration that you require.

